



[www.havayesh.com](http://www.havayesh.com)

021-73092



CLASSIC  
FAN COIL UNIT

# Saran

Life's Pleasant Breeze

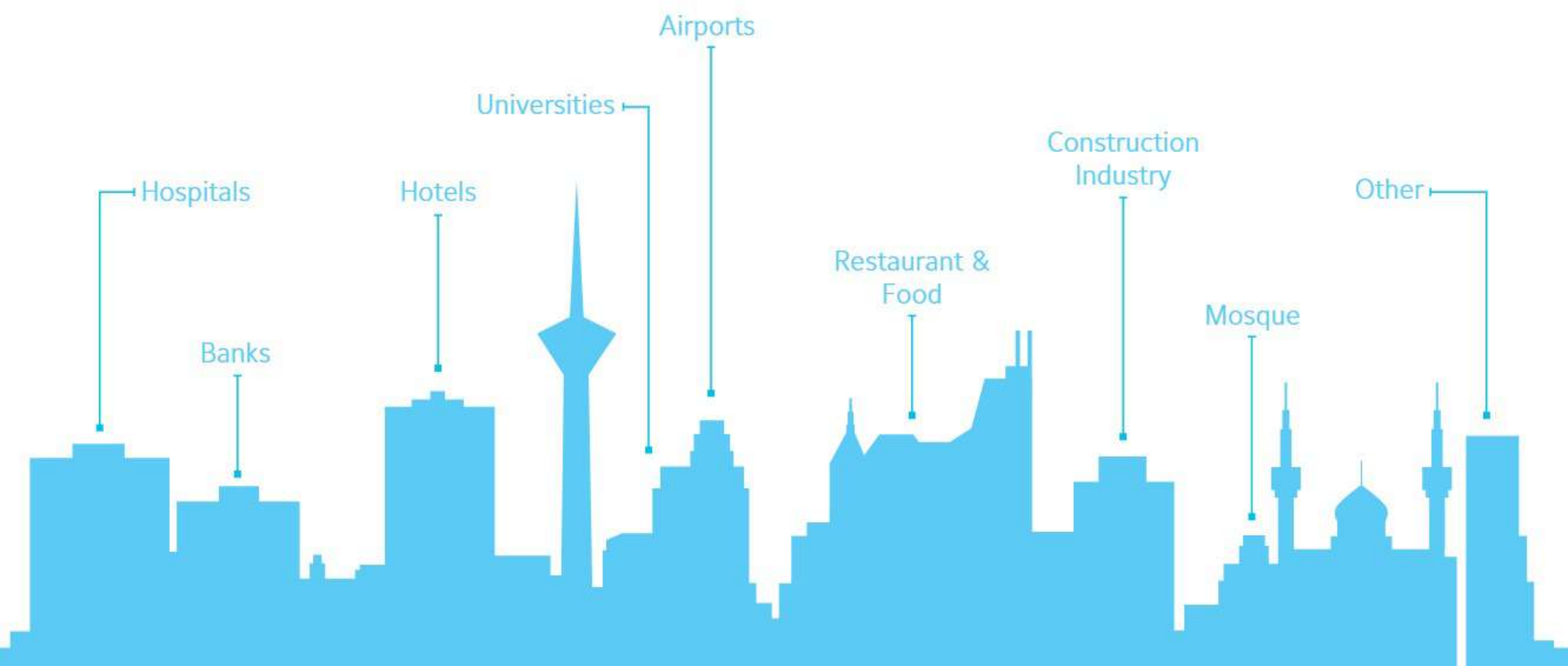

AIR CONDITIONING MFG.GROUP



# Contents

Nomenclature	4
Introduction	5
Component Features	5
Product Overview	6
Technical Data	8
Selection Consideration	8
Selection Example	9
Performance Data	10
Dimensions	12



## NOMENCLATURE

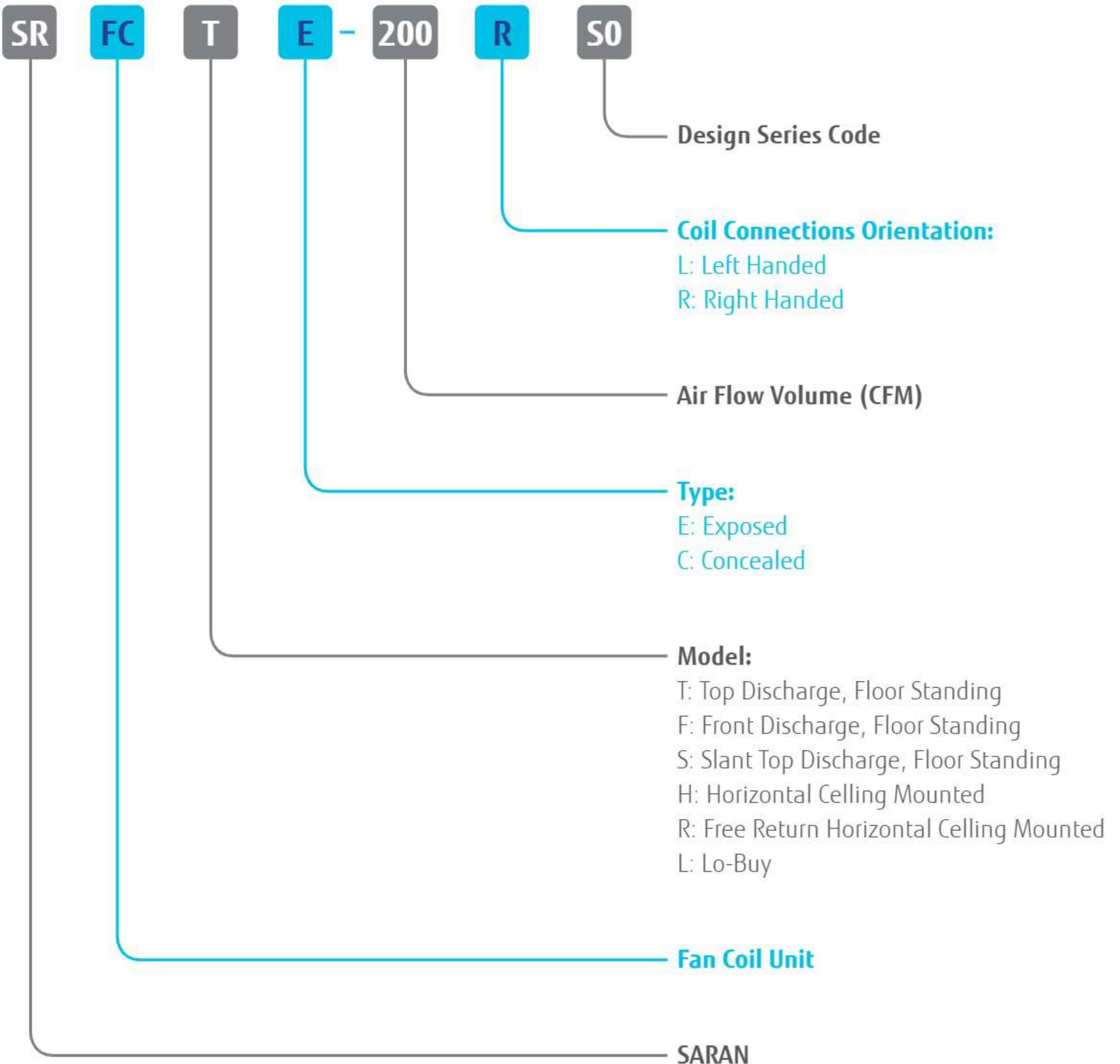



## **Introduction**

Saran classic fan coil units provide 42 models in four floor standing series (top discharge, front discharge, slant top and Lo-Boy) and two ceiling mounted series (horizontal concealed and horizontal exposed) for customers to choose. Saran classic fan coil units are available in seven sizes with airflow capacity ranging from 200 to 1200 CFM.

Saran classic fan coil units are designed specially to meet the varied requirements of zone cooling or heating using chilled water or hot water. They are suitable for use in apartments, hotels, shopping centers, office buildings, hospitals, etc.

## **Main Features**

- Heavy gauge galvanized casing
- High efficiency forward curved fan for quiet operation
- Space saving and light weight
- Low power consumption
- High efficiency coil with wavy corrugated fins
- Insulated heavy gauge drain pan
- Quick electrical connections
- Application Flexibility (floor standing and ceiling mounting series)

## **Component Features**

### **Cabinet:**

All units are constructed from heavy gauge galvanized steel sheet, which are insulation to minimize heat loss and noises produced by the unit. The highly compact, super lightweight design of the ceiling mounting series makes it ideal for inside ceiling installations where height is limited.

### **High Performance Coils:**

Cooling and Heating coils are manufactured from seamless copper tubes mechanically bonded to high efficiency wavy corrugated aluminum fins.

### **Drain Pan:**

Drain pans of all units insulated for a maximum protection against sweating and corrosion.

### **Extremely High Efficient and Quiet Operation:**

Saran classic fan coil units use centrifugal, double inlet double width, low noise fans, direct driven by single phase, 3-speed permanent split capacitor motor. These motors have integral thermal protection, low temperature rise, are highly efficient, and have high power factor and operate almost noiselessly with permanent lubricated sleeve bearings.

### **Filters:**

Saran classic fan coil units are equipped with anti-bacterial and washable synthetic media filter as standard. Washable filter is provided with easy access through return grill.



## Product Overview

### Floor Standing Models:

Floor Standing fan coil units are frequently utilized to independently provide comfort cooling and heating within a room and/or to boost the efficiency of other heating and air-conditioning system applications. Floor mounted fan coil units, frequently referred to as cabinet unit are often located against walls beneath windows or along the perimeter of a room to accommodate maximum load requirements. Typically, a thermostat mounted directly in the unit or within the space controls each fan coil unit.)



### Top Discharge Exposed Unit, (SRFCTE Series):

The SRFCTE series are exposed vertical floor standing fan coil unit with a flat top. They are supplied in a painted sheet metal enclosure. Conditioned air is supplied vertically into the space through a supply grille mounted on a flat surface atop the unit.



### Front Discharge Exposed Unit, (SRFCFE Series):

The SRFCFE series are fan coil units are the same as SRFCTE series, except that the discharge louver is located in the front.



### Slant Top Discharge Exposed Unit, (SRFCSE Series):

The SRFCSE series are exposed vertical floor standing fan coil unit with a sloped top. they are supplied in a painted sheet metal enclosure. Conditioned air is supplied vertically into the space through a supply grille mounted on a sloped surface atop the unit; the sloping of the surface helps to discourage placing items over the supply openings on the top of the unit where they have the potential to interfere with the performance of the unit. these series, designed for application in schools, institutions, hospitals and public buildings, where it is likely that books and other items would be placed over the discharge grills of a flat-top design.



### Lo-Boy Exposed Unit, (SRFCLE Series):

The SRFCLE series are a low profile version of the standard SRFCSE series. they are factory supplied in a painted sheet metal enclosure with specific consideration for height constraints such as windows that are located lower on the wall.



## Product Overview (Cont.)

### Ceiling Mounted Models:

Horizontal ceiling mounted fan coil units are most commonly utilized to provide comfort cooling and heating to a space and are typically mounted above or flush with the ceiling or in a soffit. A thermostat mounted in the space may control each fan coil unit.



### Horizontal Ceiling Exposed Model, (SRFCHE Series):

The SRFCHE Series fan coil units, most commonly used in high-bay open areas, are designed to be installed in the space below the ceiling and is fully exposed. Return air is drawn in through return air grilles located on the bottom of the unit, and air is supplied into the space horizontally through a supply air grille in the side of the unit.



### Free Return Horizontal Ceiling Concealed Model, (SRFCRC Series):

The SRFCRC Series fan coil units are designed for above ceiling or soffit installation. Conditioned air is supplied horizontally through a sidewall supply air grille; return air is re-circulated through the unit via a plenum or ducted return system. The ceiling concealed unit is suitable for external static pressures of up to 30 Pa.



### Horizontal Ceiling Concealed Model, (SRFCHC Series):

The SRFCHC Series fan coil units are designed for above ceiling or soffit installation, but the fan section on this model is located within an insulated plenum for sound attenuation. Conditioned air is supplied horizontally through a sidewall supply air grille, and return air is re-circulated through the unit via plenum or ducted return system (back or bottom return air intake configuration available). The ceiling concealed unit is suitable for external static pressures of up to 30 Pa.

## Technical Data

Table 1

Model	SRFC-200	SRFC-300	SRFC-400	SRFC-600	SRFC-800	SRFC-1000	SRFC-1200	
Nominal Air Flow Rate (CFM)	200	300	400	600	800	1000	1200	
Total Heating Capacity (Btu/hr)	20750	30420	37970	52080	66110	79770	93060	
Total Cooling Capacity (Btu/hr)	8970	12830	15960	21700	27930	34920	41710	
Coil Data	Coil Face Area (Sq Ft)	0.97	1.40	1.63	1.92	2.51	3.17	4.00
	Tube Size	3/8" OD						
	No. of Rows	3						
	Fins Per Inch	12						
No. of Motors	1	1	1	1	2	2	2	
Nominal Power (W)	25	25	25	30	25 & 30	25	30	
Rated Current (Amp)	0.22	0.19	0.22	0.33	0.48	0.52	0.66	
Drain Pipe	3/4"							
Noise (dBA)	41	40	38	39	38	40	41	
Weight (kg)	24.5	29.5	31.5	36	45.5	56	68	

### NOTE

- Cooling capacities are based on entering chilled water temperature of 44°F and entering air temperature of 80°F DB/ 67°F WB at fan high speed.
- Heating capacities are based on entering hot water temperature of 180°F and entering air temperature of 68°F DB at fan high speed.
- For Concealed and Lo-Boy series fan coil units, above weights reduce approximately 20%.

## Selection Considerations

Following factors should be considered for selecting of Saran classic fan coil units:

- Available space for the unit including floor to ceiling height
- Type of application (Standard / District cooling)
- Presence of high sensible or peripheral loads in space
- Functionality of intended space usage
- Availability of access for pipes, drains and power
- Compatibility with intended space finish
- Fresh air and ventilation requirements
- Noise level desired at peak or part load operations
- Control system desired especially if winter heating is required
- Economy of layout

Saran classic fan coil units rating data presented in the "Performance Data" tables indicate capacity of the fan coil units at fan full speed on sea level altitude; so for other condition, following performance adjustment factors shall be attend in unit selection:

Table 2: Altitude Correction Factors

Altitude (ft)	0	1000	2000	3000	4000	5000	6000
Total Cooling Capacity	1.00	0.99	0.98	0.97	0.96	0.94	0.93
Sensible Cooling Capacity	1.00	0.96	0.93	0.90	0.86	0.83	0.80
Total Heating Capacity	1.00	0.97	0.94	0.90	0.87	0.83	0.81

Table 3: Fan Speed Correction Factors

Fan Speed	High	Medium	Low
Total Cooling Capacity	1.00	0.86	0.78
Sensible Cooling Capacity	1.00	0.83	0.73
Total Heating Capacity	1.00	0.84	0.74



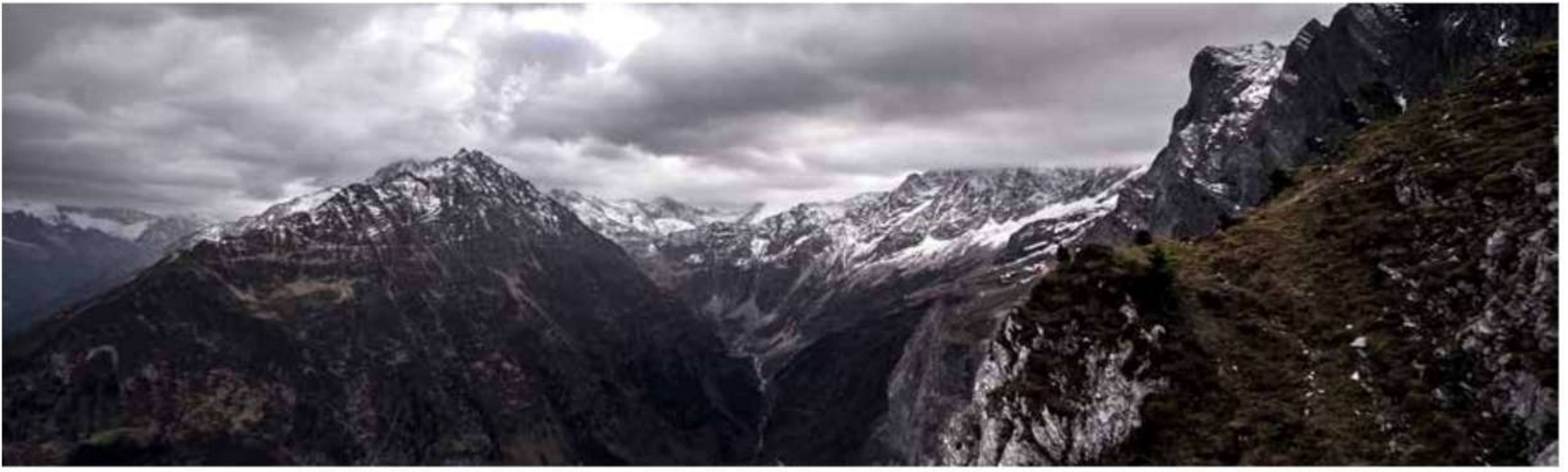

## Selection Example

### Given:

Required Air Flow Rate: 600 CFM  
 Ambient Altitude: 4000 ft  
 Fan Speed: Medium

### Summer Conditions

Total Cooling Load: 16000 Btu/hr  
 Sensible Cooling Load: 9900 Btu/hr  
 Entering Air Temperature: 80°F DB / 67°F WB  
 Entering Water Temperature: 46°F

### Winter Conditions

Total Heating Load: 29000 Btu/hr  
 Entering Air Temperature: 72°F DB  
 Entering Water Temperature: 160°F

### Step1: Appropriate Fan Coil Unit Selection:

Because of we need 600 CFM air flow rate, in first step we select SRFC-600. By referring to performance table, we can see total and sensible cooling capacity of this unit with 4.5 GPM chilled water flow rate in given summer conditions are 19950 Btu/hr and 13870 Btu/hr, respectively. In addition, heating capacity of this unit with 4.5 GPM hot water flow rate in given winter conditions is 40460 Btu/hr.

### Step2: Comparison of Selected Model Performance with Our Requirements:

In this step, we check selected model performance in our condition:

Because of fan coil units performance tables are based on sea level altitude and fan high speed, we should be using load adjustment factor in our conditions, so by referring to tables 2 and 3, we have:

- Actual Total Cooling Capacity =  $19950 \times 0.96 \times 0.86 = 16470$  Btu/hr
- Actual Sensible Cooling Capacity =  $13870 \times 0.86 \times 0.83 = 9900$  Btu/h
- Actual Heating Capacity =  $40460 \times 0.87 \times 0.84 = 29568$  Btu/hr

Therefore, the chosen unit satisfies the load requirements.

### Step 3: Determine Water Flow Range

To determine water flow range, we can using following formula:

$$\text{Chilled water flow range (°F)} = \frac{\text{Actual Total Cooling Capacity (Btu/hr)}}{500 \times \text{Chilled Water Flow Rate (GPM)}} = \frac{16470}{500 \times 4.5} = 7.3^\circ\text{F}$$

$$\text{Hot water flow range (°F)} = \frac{\text{Actual Heating Capacity (Btu/hr)}}{500 \times \text{Hot Water Flow Rate (GPM)}} = \frac{29568}{500 \times 4.5} = 13.1^\circ\text{F}$$



## Performance Data

Table 4: Chilled Water Rating Data

Model	Water Inlet Temperature (°F)	Water Flow Rate (GPM)	Water Pressure Drop (FLWG)	Air Inlet Temperature (°F)					
				75DB/63WB		77DB/65WB		80DB/67WB	
				Sensible (Btu/hr)	Total (Btu/hr)	Sensible (Btu/hr)	Total (Btu/hr)	Sensible (Btu/hr)	Total (Btu/hr)
SRFC - 200	42	1.5	1.2	5240	6670	5440	7410	5850	8200
		2	2	5540	7360	5770	8180	6210	9040
		2.5	3.1	5740	7810	6000	8720	6470	9650
	44	1.5	1.2	4990	6070	5190	6820	5610	7600
		2	2	5260	6700	5500	7570	5930	8370
		2.5	3.1	5440	7120	5710	8040	6180	8970
	46	1.5	1.2	4790	5600	4950	6220	5370	7010
		2	2	4980	6040	5220	6900	5670	7750
		2.5	3.1	5160	6470	5420	7360	5880	8260
SRFC - 300	42	2	2.5	6910	8800	7630	10990	8170	12030
		2.5	3.7	7360	9900	8000	11870	8600	13090
		3	4.9	7950	11290	8270	12520	8920	13860
	44	2	2.5	6980	8990	7280	10110	7860	11250
		2.5	3.7	7270	9690	7580	10870	8230	12170
		3	4.9	7520	10290	7860	11550	8490	12830
	46	2	2.5	6660	8180	6920	9190	7510	10350
		2.5	3.7	6890	8760	7210	9950	7830	11180
		3	4.9	7090	9240	7450	10540	8110	11880
SRFC - 400	42	2.5	4	9290	12510	9640	13900	10340	15280
		3	5.4	9640	13340	10040	14860	10780	16360
		3.5	7.1	9930	14020	10340	15580	11140	17230
	44	2.5	4	8860	11470	9170	12740	9900	14160
		3	5.4	9150	12180	9530	13630	10300	15190
		3.5	7.1	9400	12770	9840	14380	10620	15960
	46	2.5	4	8480	10520	8760	11690	9480	13090
		3	5.4	8680	11030	9080	12520	9840	14010
		3.5	7.1	8880	11520	9290	13030	10110	14710
SRFC - 600	42	3.5	8.1	12970	17510	13480	19500	14460	21430
		4	10.3	13340	18410	13850	20400	14890	22500
		4.5	12.7	13630	19070	14190	21210	15260	23410
	44	3.5	8.1	12360	16050	12840	17930	13880	19960
		4	10.3	12660	16760	13180	18760	14220	20820
		4.5	12.7	12910	17380	13500	19540	14570	21700
	46	3.5	8.1	11780	14600	12240	16400	13250	18360
		4	10.3	12030	15220	12520	17120	13590	19240
		4.5	12.7	12230	15710	12800	17830	13870	19950

### NOTE

- Capacities are based on fan high speed and sea level altitude. For other condition, performance adjustment factors shall be attend in fan coil units selection (See Table 2&3).



## Performance Data (Cont.)

Table 5: Hot Water Rating Data

Model	Water Inlet Temperature (°F)	Water Flow Rate (GPM)	Water Pressure Drop (Ft.WG)	Air Inlet Temperature (°F)			Model	Water Inlet Temperature (°F)	Water Flow Rate (GPM)	Water Pressure Drop (Ft.WG)	Air Inlet Temperature (°F)		
				68 DB	70 DB	72 DB					68 DB	70 DB	72 DB
				Heating Capacity (Btu/hr)	Heating Capacity (Btu/hr)	Heating Capacity (Btu/hr)					Heating Capacity (Btu/hr)	Heating Capacity (Btu/hr)	Heating Capacity (Btu/hr)
SRFC - 200	140	2	1.4	13070	12710	12340	SRFC - 800	140	6	19.7	42720	41530	40340
		2.5	2.1	13390	13010	12630			6.5	22.7	43070	41860	40660
		3	2.8	13600	13220	12840			7	25.9	43360	42150	40940
	160	2	1.4	16580	16210	15850		160	6	19.7	54080	52890	51710
		2.5	2.1	16960	16580	16210			6.5	22.7	54500	53310	52110
		3	2.8	17220	16840	16460			7	25.9	54870	53660	52460
	180	2	1.4	20010	19650	19290		180	6	19.7	65190	64010	62840
		2.5	2.1	20450	20080	19710			6.5	22.7	65690	64500	63320
		3	2.8	20750	20380	20000			7	25.9	66110	64920	63730
SRFC - 300	140	3	3.8	19440	18890	18350	SRFC - 1000	140	7.5	15.9	51670	50220	48780
		3.5	5	19730	19180	18620			8	17.9	52010	50550	49100
		4	6.3	19950	19390	18830			8.5	19.9	52310	50840	49380
	160	3	3.8	24610	24070	23530		160	7.5	15.9	65400	63970	62530
		3.5	5	24970	24420	23870			8	17.9	65820	64370	62930
		4	6.3	25240	24690	24130			8.5	19.9	66190	64740	63280
	180	3	3.8	29680	29150	28610		180	7.5	15.9	78840	77420	76000
		3.5	5	30100	29550	29010			8	17.9	79330	77900	76470
		4	6.3	30420	29860	29310			8.5	19.9	79770	78330	76890
SRFC - 400	140	3.5	5.5	24290	23610	22930	SRFC - 1200	140	7.5	19	60220	58540	56860
		4	6.7	24630	23940	23250			8	21.3	60660	58970	57270
		4.5	8.3	24890	24200	23500			8.5	23.8	61050	59350	57640
	160	3.5	5.5	30770	30090	29420		160	7.5	19	76200	74540	72870
		4	6.7	31180	30490	29810			8	21.3	76750	75070	73390
		4.5	8.3	31500	30810	30120			8.5	23.8	77230	75540	73850
	180	3.5	5.5	37110	36440	35770		180	7.5	19	91840	90190	88540
		4	6.7	37590	36910	36230			8	21.3	92490	90820	89150
		4.5	8.3	37970	37280	36600			8.5	23.8	93060	91380	89700
SRFC - 600	140	4.5	9.3	33390	32460	31530	SRFC - 1200	140	7.5	19	60220	58540	56860
		5	11.7	33790	32840	31900			8	21.3	60660	58970	57270
		5.5	13.9	34110	33160	32210			8.5	23.8	61050	59350	57640
	160	4.5	9.3	42310	41380	40460		160	7.5	19	76200	74540	72870
		5	11.7	42790	41850	40920			8	21.3	76750	75070	73390
		5.5	13.9	43190	42240	41300			8.5	23.8	77230	75540	73850
	180	4.5	9.3	51040	50120	49210		180	7.5	19	91840	90190	88540
		5	11.7	51610	50680	49750			8	21.3	92490	90820	89150
		5.5	13.9	52080	51140	50200			8.5	23.8	93060	91380	89700

**NOTE**

- Capacities are based on fan high speed and sea level altitude. For other condition, performance adjustment factors shall be attend in fan coil units selection (See Table 2&3).



## Dimensions

### Top and Front Discharge, Floor Standing Exposed

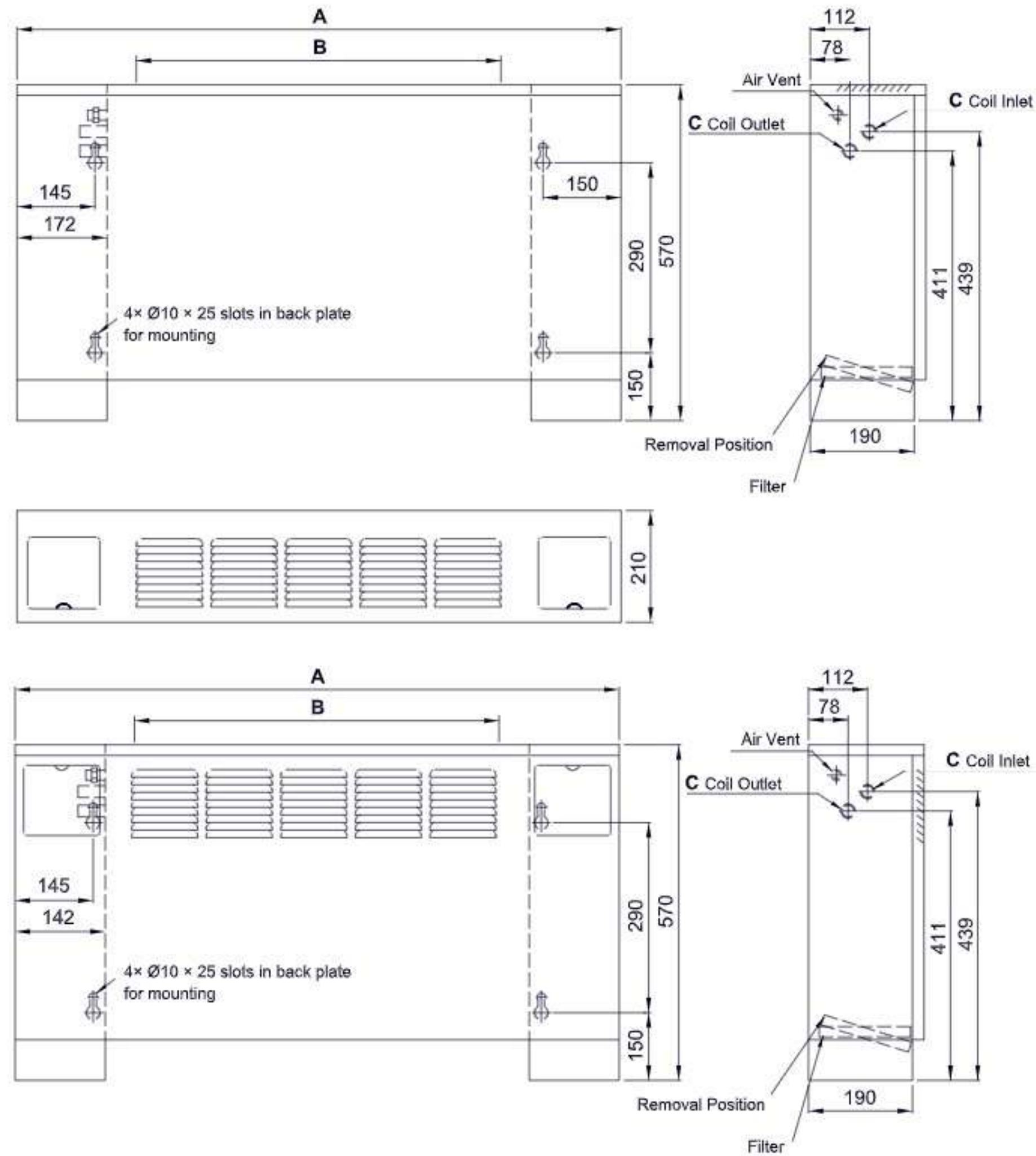

Table 6

Model	A	B	C
SRFC-200	920	510	3/4" FPT
SRFC-300	1120	640	3/4" FPT
SRFC-400	1220	780	3/4" FPT
SRFC-600	1360	910	3/4" FPT
SRFC-800	1620	1180	3/4" FPT
SRFC-1000	1920	1440	3/4" FPT
SRFC-1200	2270	1840	3/4" FPT

#### NOTE

- Left handed coil connections are shown.
- To order desired model add proper characters to model see nomenclature.
- All dimensions in mm.

## Dimensions (Cont.)

### Slant Top Discharge, Floor Standing Exposed

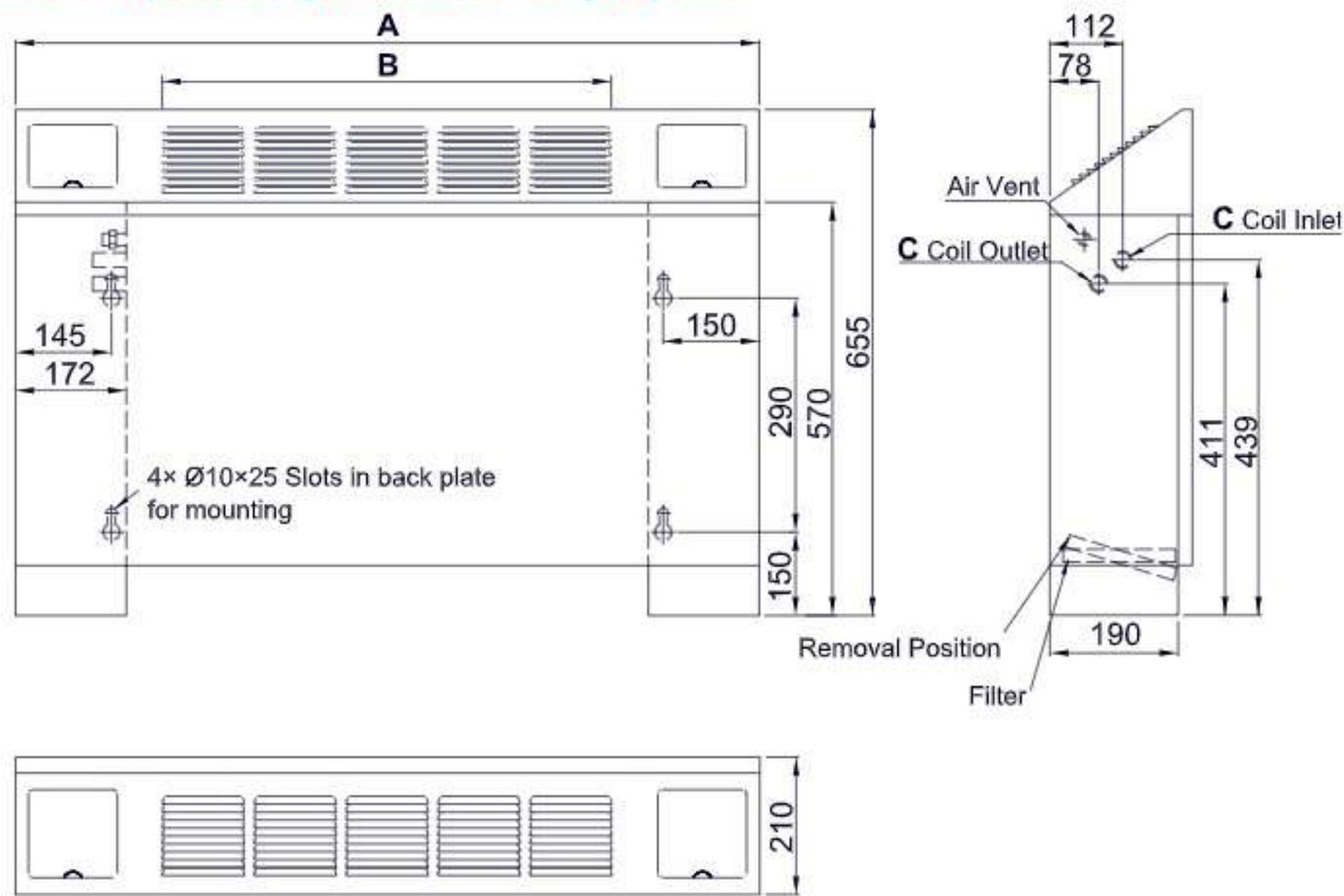

Table 7

Model	A	B	C
SRFC-200	920	510	3/4" FPT
SRFC-300	1120	640	3/4" FPT
SRFC-400	1220	780	3/4" FPT
SRFC-600	1360	910	3/4" FPT
SRFC-800	1620	1180	3/4" FPT
SRFC-1000	1920	1440	3/4" FPT
SRFC-1200	2270	1840	3/4" FPT

#### NOTE

- Left handed coil connections are shown.
- To order desired model add proper characters to model see nomenclature.
- All dimensions in mm.

### Lo - Boy

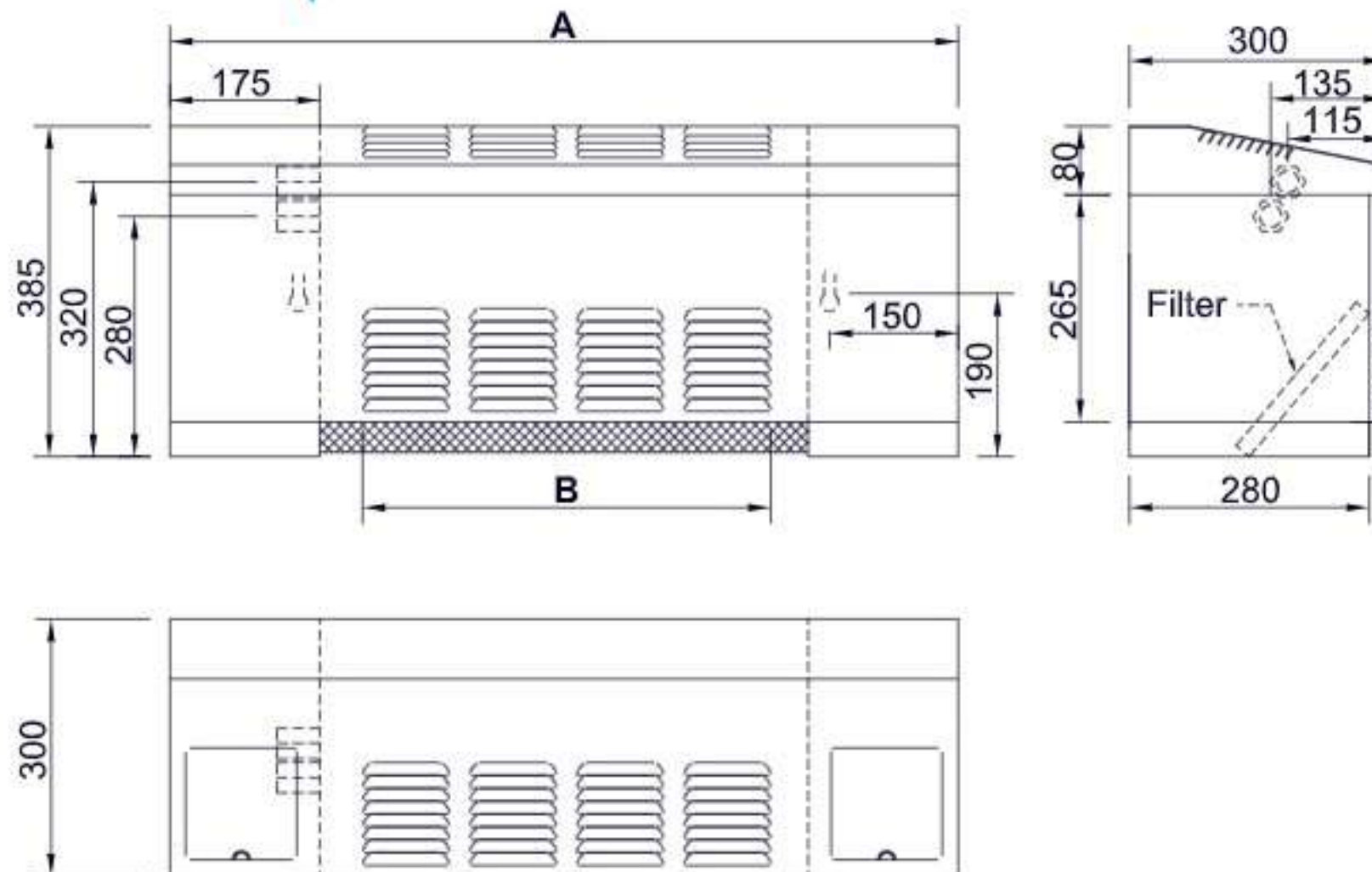

Table 8

Model	A	B	C
SRFC-200	920	510	3/4" FPT
SRFC-300	1120	640	3/4" FPT
SRFC-400	1220	780	3/4" FPT
SRFC-600	1360	910	3/4" FPT
SRFC-800	1620	1180	3/4" FPT
SRFC-1000	1920	1440	3/4" FPT
SRFC-1200	2270	1840	3/4" FPT

#### NOTE

- Left handed coil connections are shown.
- To order desired model add proper characters to model see nomenclature.
- All dimensions in mm.

## Dimensions (Cont.)

### Horizontal Ceiling Mounted, Exposed

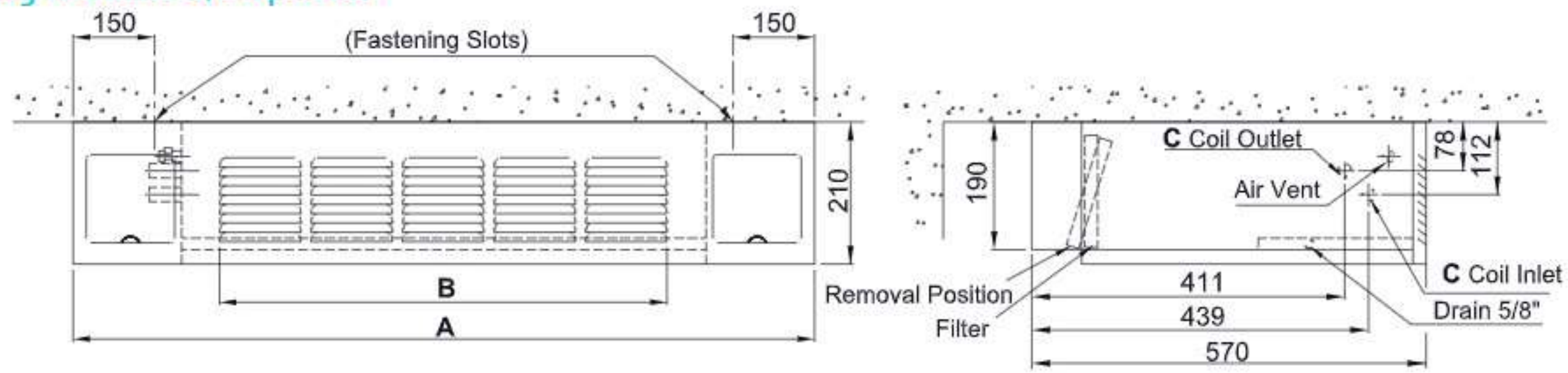

Table 9

Model	A	B	C
SRFC-200	920	510	3/4" FPT
SRFC-300	1120	640	3/4" FPT
SRFC-400	1220	780	3/4" FPT
SRFC-600	1360	910	3/4" FPT
SRFC-800	1620	1180	3/4" FPT
SRFC-1000	1920	1440	3/4" FPT
SRFC-1200	2270	1840	3/4" FPT

#### NOTE

- Left handed coil connections are shown.
- To order desired model add proper characters to model see nomenclature.
- All dimensions in mm.

### Horizontal Ceiling Mounted, Concealed

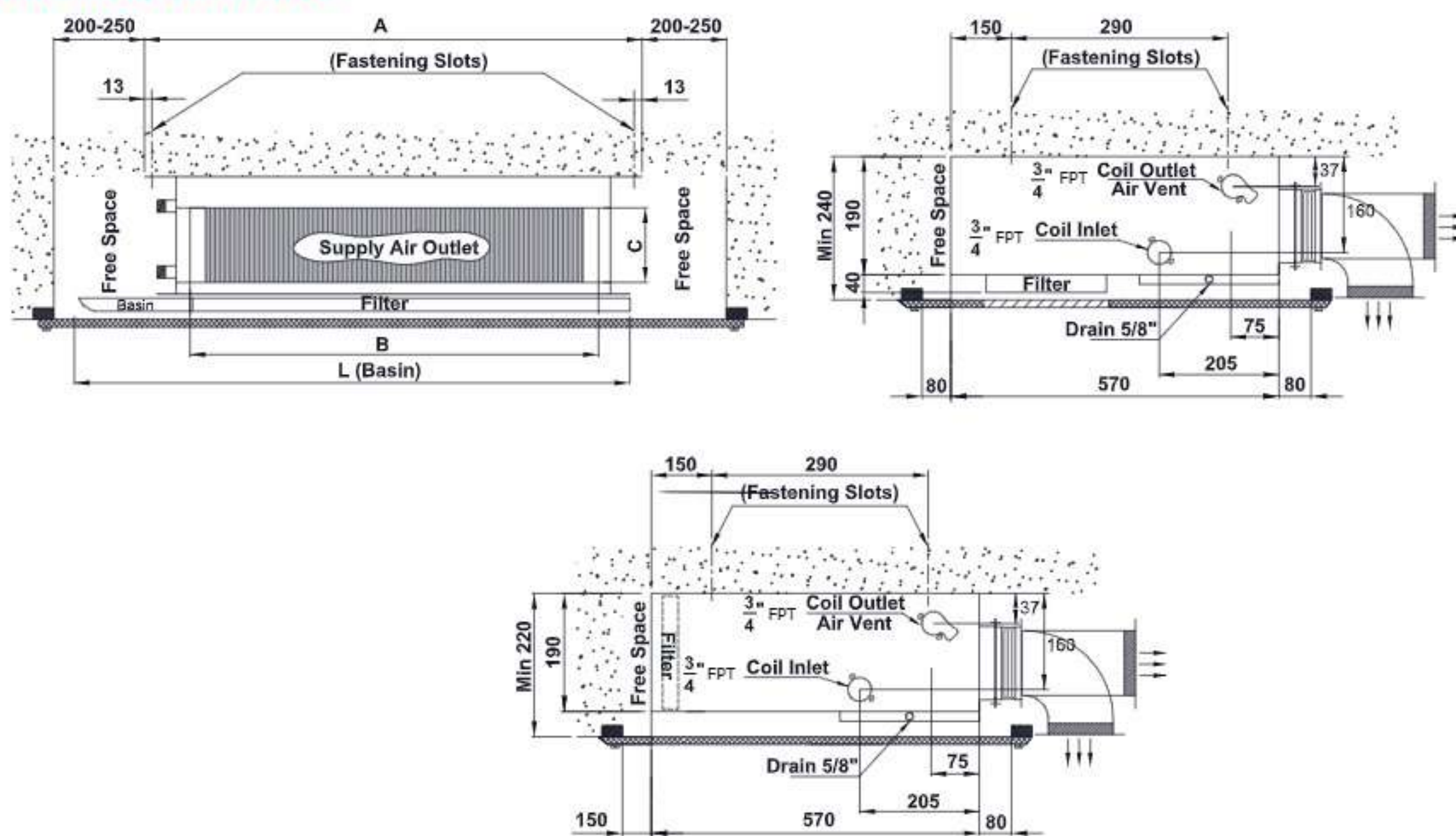

Table 10

Model	A	B	C	L
SRFC-200	650	540	155	810
SRFC-300	850	740	155	1060
SRFC-400	950	840	155	1060
SRFC-600	1090	980	155	1195
SRFC-800	1350	1240	155	1480
SRFC-1000	1650	1540	145	1720
SRFC-1200	2000	1860	145	2070

#### NOTE

- Left handed coil connections are shown.
- To order desired model add proper characters to model see nomenclature.
- All dimensions in mm.